

IG 34/42 - S with HE Feedback

Model Numbering

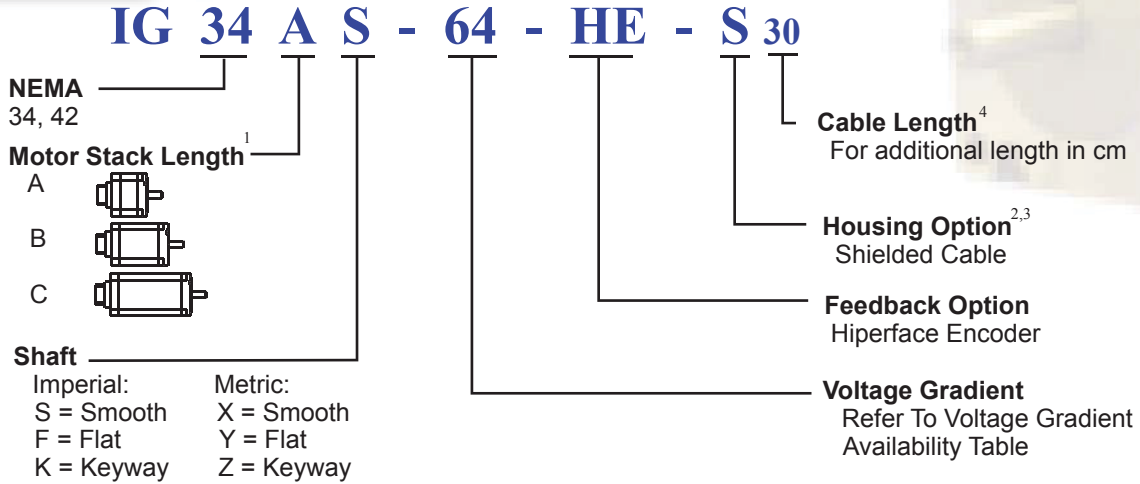

1. Refer to Dimensions for the exact length and shaft options
2. All the motors are rated IP64 and by adding front shaft seal it's rating becomes IP65
3. Comes with 18 inches (46cm) shielded cable
4. Blank for Standard length (18 inches = 46 cm)

Voltage Gradient

Voltage Constant K_E (V/kRPM)		16	22	32	44	64	88	130	180	260	360
Frame Size	IG 34										
	IG 42										

Performance Curves

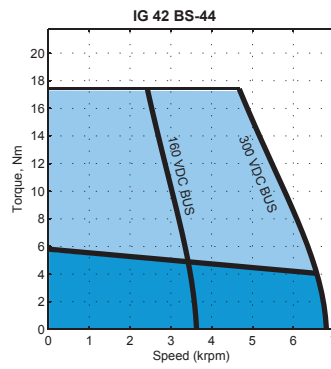
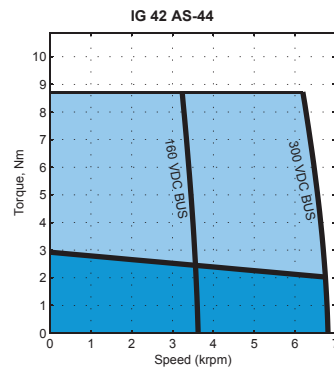
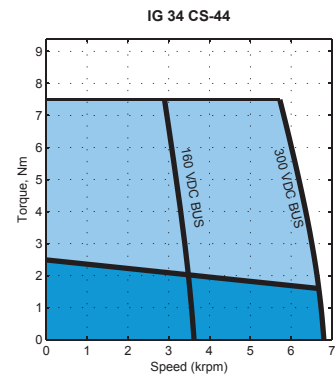
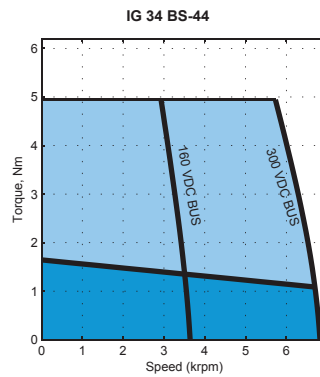
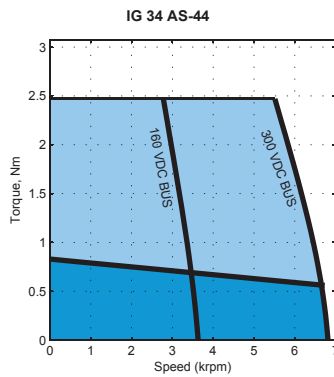

Contact factory for torque-speed curves of other motors

Mar, 08, 06

IG 34/42 - S with HE Feedback

Motor Specification

NEMA 34																		
Index	Model Number	Weight		Torque Constant (Peak) (L2L)		Voltage Constant	Cont. Stall Torque		Cont. Stall Current	Peak Stall Torque		Peak Stall Current	Max BEMF (Peak) (L2L)	Max Speed	L-to-L Resistance	L-to-L Inductance	Rotor Inertia	
		W		K _T		K _E	T _{cs}		I _{cs}	T _P		I _P	U _{max}	n _{max}	R	L	J	
		kg	lb	Nm/A	lb-in/A	V/krpm	Nm	lb-in	A	Nm	lb-in	A	V	rpm	Ohms	mH	kg-cm ²	lb-in-sec ²
43	IG 34 AS - 16	1.90	4.19	0.18	1.56	16.00	0.82	7.26	4.65	2.46	21.77	13.94	128.00	8000	0.34	1.10	0.80	0.00071
44	IG 34 BS - 16	2.90	6.39	0.18	1.56	16.00	1.65	14.60	9.35	4.95	43.81	28.06	128.00	8000	0.14	0.45	1.60	0.00142
45	IG 34 CS - 16	3.90	8.60	0.18	1.56	16.00	2.50	22.13	14.17	7.50	66.38	42.51	128.00	8000	0.10	0.39	2.40	0.00212
46	IG 34 AS - 22	1.90	4.19	0.24	2.15	22.00	0.82	7.26	3.38	2.46	21.77	10.14	176.00	8000	0.81	2.50	0.80	0.00071
47	IG 34 BS - 22	2.90	6.39	0.24	2.15	22.00	1.65	14.60	6.80	4.95	43.81	20.40	176.00	8000	0.56	0.95	1.60	0.00142
48	IG 34 CS - 22	3.90	8.60	0.24	2.15	22.00	2.50	22.13	10.30	7.50	66.38	30.91	176.00	8000	0.20	0.70	2.40	0.00212
49	IG 34 AS - 32	1.90	4.19	0.35	3.12	32.00	0.82	7.26	2.32	2.46	21.77	6.97	256.00	8000	2.10	6.30	0.80	0.00071
50	IG 34 BS - 32	2.90	6.39	0.35	3.12	32.00	1.65	14.60	4.68	4.95	43.81	14.03	256.00	8000	0.74	2.70	1.60	0.00142
51	IG 34 CS - 32	3.90	8.60	0.35	3.12	32.00	2.50	22.13	7.08	7.50	66.38	21.25	256.00	8000	0.40	1.47	2.40	0.00212
52	IG 34 AS - 44	1.90	4.19	0.49	4.29	44.00	0.82	7.26	1.69	2.46	21.77	5.07	352.00	8000	3.80	12.30	0.80	0.00071
53	IG 34 BS - 44	2.90	6.39	0.49	4.29	44.00	1.65	14.60	3.40	4.95	43.81	10.20	352.00	8000	1.50	5.50	1.60	0.00142
54	IG 34 CS - 44	3.90	8.60	0.49	4.29	44.00	2.50	22.13	5.15	7.50	66.38	15.46	352.00	8000	1.10	3.50	2.40	0.00212
55	IG 34 AS - 64	1.90	4.19	0.71	6.25	64.00	0.82	7.26	1.16	2.46	21.77	3.49	512.00	8000	8.60	27.70	0.80	0.00071
56	IG 34 BS - 64	2.90	6.39	0.71	6.25	64.00	1.65	14.60	2.34	4.95	43.81	7.01	512.00	8000	3.45	12.30	1.60	0.00142
57	IG 34 CS - 64	3.90	8.60	0.71	6.25	64.00	2.50	22.13	3.54	7.50	66.38	10.63	512.00	8000	2.10	7.80	2.40	0.00212
58	IG 34 AS - 88	1.90	4.19	0.97	8.59	88.00	0.82	7.26	0.85	2.46	21.77	2.54	704.00	8000	13.50	45.20	0.80	0.00071
59	IG 34 BS - 88	2.90	6.39	0.97	8.59	88.00	1.65	14.60	1.70	4.95	43.81	5.10	704.00	8000	5.50	19.00	1.60	0.00142
60	IG 34 CS - 88	3.90	8.60	0.97	8.59	88.00	2.50	22.13	2.58	7.50	66.38	7.73	704.00	8000	3.50	12.50	2.40	0.00212
61	IG 34 AS - 130	1.90	4.19	1.43	12.69	130.00	0.82	7.26	0.57	2.46	21.77	1.72	1,040.00	8000	22.50	72.80	0.80	0.00071
62	IG 34 BS - 130	2.90	6.39	1.43	12.69	130.00	1.65	14.60	1.15	4.95	43.81	3.45	1,040.00	8000	8.30	30.00	1.60	0.00142
63	IG 34 CS - 130	3.90	8.60	1.43	12.69	130.00	2.50	22.13	1.74	7.50	66.38	5.23	1,040.00	8000	5.10	20.00	2.40	0.00212
64	IG 34 AS - 180	1.90	4.19	1.98	17.57	180.00	0.82	7.26	0.41	2.46	21.77	1.24	1,440.00	8000	46.00	141.30	0.80	0.00071
65	IG 34 BS - 180	2.90	6.39	1.98	17.57	180.00	1.65	14.60	0.83	4.95	43.81	2.49	1,440.00	8000	17.60	56.70	1.60	0.00142
66	IG 34 CS - 180	3.90	8.60	1.98	17.57	180.00	2.50	22.13	1.26	7.50	66.38	3.78	1,440.00	8000	10.20	38.00	2.40	0.00212
67	IG 34 AS - 260	1.90	4.19	2.87	25.38	260.00	0.82	7.26	0.29	2.46	21.77	0.86	2,080.00	8000	97.20	295.30	0.80	0.00071
68	IG 34 BS - 260	2.90	6.39	2.87	25.38	260.00	1.65	14.60	0.58	4.95	43.81	1.73	2,080.00	8000	33.50	118.50	1.60	0.00142
69	IG 34 CS - 260	3.90	8.60	2.87	25.38	260.00	2.50	22.13	0.87	7.50	66.38	2.62	2,080.00	8000	20.50	79.00	2.40	0.00212
70	IG 34 AS - 360	1.90	4.19	3.97	35.14	360.00	0.82	7.26	0.21	2.46	21.77	0.62	2,880.00	8000	173.00	568.00	0.80	0.00071
71	IG 34 BS - 360	2.90	6.39	3.97	35.14	360.00	1.65	14.60	0.42	4.95	43.81	1.25	2,880.00	8000	67.30	227.00	1.60	0.00142
72	IG 34 CS - 360	3.90	8.60	3.97	35.14	360.00	2.50	22.13	0.63	7.50	66.38	1.89	2,880.00	8000	18.70	153.00	2.40	0.00212

NEMA 42																		
Index	Model Number	Weight		Torque Constant (Peak) (L2L)		Voltage Constant	Cont. Stall Torque		Cont. Stall Current	Peak Stall Torque		Peak Stall Current	Max BEMF (Peak) (L2L)	Max Speed	L-to-L Resistance	L-to-L Inductance	Rotor Inertia	
		W		K _T		K _E	T _{cs}		I _{cs}	T _P		I _P	U _{max}	n _{max}	R	L	J	
		kg	lb	Nm/A	lb-in/amp	V/krpm	Nm	lb-in	A	Nm	lb-in	A	V	rpm	Ohms	mH	kg-cm ²	lb-in-sec ²
73	IG 42 AS - 32	5.50	12.13	0.35	3.12	32.00	2.90	25.67	8.22	8.70	77.00	24.65	192.00	6000	0.20	1.10	3.00	0.00266
74	IG 42 BS - 32	9.20	20.28	0.35	3.12	32.00	5.80	51.33	16.44	17.40	154.00	49.31	192.00	6000	0.16	1.40	6.00	0.00531
75	IG 42 AS - 44	5.50	12.13	0.49	4.29	44.00	2.90	25.67	5.98	8.70	77.00	17.93	264.00	6000	0.38	2.30	3.00	0.00266
76	IG 42 BS - 44	9.20	20.28	0.49	4.29	44.00	5.80	51.33	11.95	17.40	154.00	35.86	264.00	6000	0.33	2.90	6.00	0.00531
77	IG 42 AS - 64	5.50	12.13	0.71	6.25	64.00	2.90	25.67	4.11	8.70	77.00	12.33	384.00	6000	1.10	5.00	3.00	0.00266
78	IG 42 BS - 64	9.20	20.28	0.71	6.25	64.00	5.80	51.33	8.22	17.40	154.00	24.65	384.00	6000	0.69	6.40	6.00	0.00531
79	IG 42 AS - 88	5.50	12.13	0.97	8.59	88.00	2.90	25.67	2.99	8.70	77.00	8.97	528.00	6000	1.70	8.00	3.00	0.00266
80	IG 42 BS - 88	9.20	20.28	0.97	8.59	88.00	5.80	51.33	5.98	17.40	154.00	17.93	528.00	6000	1.15	10.50	6.00	0.00531
81	IG 42 AS - 130	5.50	12.13	1.43	12.69	130.00	2.90	25.67	2.02	8.70	77.00	6.07	780.00	6000	2.35	12.70	3.00	0.00266
82	IG 42 BS - 130	9.20	20.28	1.43	12.69	130.00	5.80	51.33	4.05	17.40	154.00	12.14	780.00	6000	1.80	16.70	6.00	0.00531
83	IG 42 AS - 180	5.50	12.13	1.98	17.57	180.00	2.90	25.67	1.46	7.50	66.38	3.78	1,080.00	6000	5.80	25.00	3.00	0.00266
84	IG 42 BS - 180	9.20	20.28	1.98	17.57	180.00	5.80	51.33	2.92	15.00	132.76	7.56	1,080.00	6000	3.50	32.00	6.00	0.00531
85	IG 42 AS - 260	5.50	12.13	2.87	25.38	260.00	2.90	25.67	1.01	7.50	66.38	2.62	1,560.00	6000	11.80	50.70	3.00	0.00266
86	IG 42 BS - 260	9.20	20.28	2.87	25.38	260.00	5.80	51.33	2.02	15.00	132.76	5.23	1,560.00	6000	7.50	67.00	6.00	0.00531
87	IG 42 AS - 360	5.50	12.13	3.97	35.14	360.00	2.90	25.67	0.73	7.50	66.38	1.89	2,160.00	6000	20.30	97.80	3.00	0.00266
88	IG 42 BS - 360	9.20	20.28	3.97	35.14	360.00	5.80	51.33	1.46	15.00	132.76	3.78	2,160.00	6000	14.20	128.00	6.00	0.00531

L2L: Line-to-Line

Mar, 08, 06

IG 34/42 with S Housing and HE Feedback

Motor Drawing

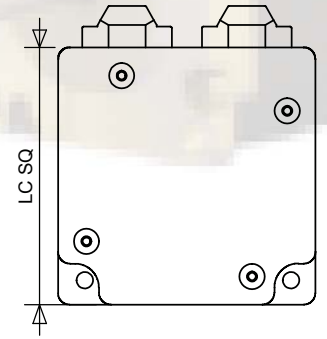
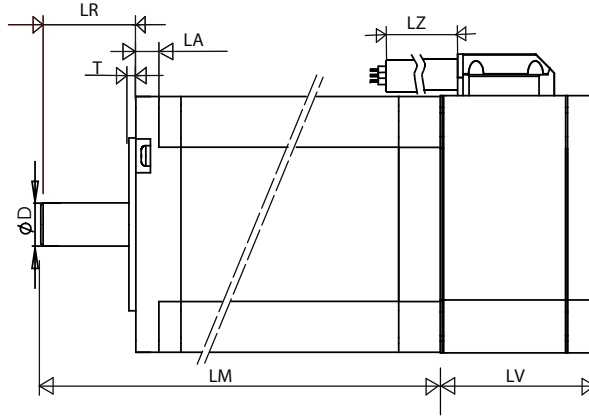
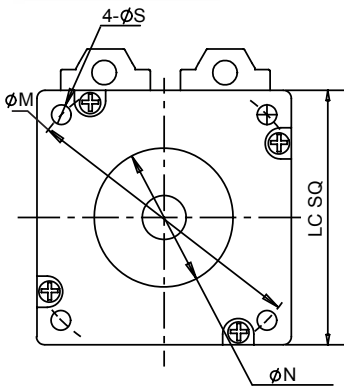

FRONT SHAFT OPTIONS
 (1) SMOOTH SHAFT, AS SHOWN IN THE VIEWS
 (2) KEYWAY SHAFT
 (3) FLAT SHAFT

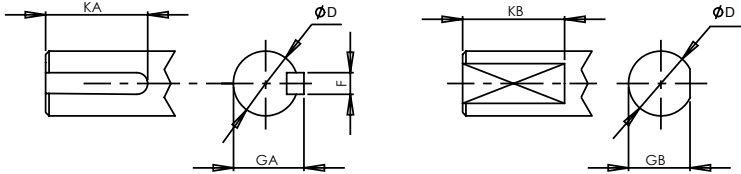

NOTE:
 ALL THE MOTORS ARE RATED IP64 AND BY ADDING FRONT SHAFT SEAL, IT'S RATING BECOMES IP65

Units: inches (mm)

IG		LM	LV	LA	T	LR	LC	LZ	N	S	M
34	A	2.795 (71)	2.0 (50.7)	0.33 (8.4)	0.059 (1.5)	1.260 (32)	3.386 (86.0)	18 (457.2)	2.875 ⁰ _{-0.0012} (73.03 ⁰ _{-0.031})	0.217 (5.5)	3.875 (98.43)
	B	3.858 (98)									
	C	4.921 (125)									
42	A	4.449 (113)	2.0 (50.7)	0.49 (12.5)	0.059 (1.5)	2.126 (54)	4.332 (110.0)	18 (457.2)	2.186 ⁰ _{-0.0018} (55.52 ⁰ _{-0.046})	0.335 (8.5)	4.950 (125.73)
	B	6.811 (173)									
	C	-									

IG	Imperial Shaft Option (S/F/K), Units: inches						Metric Shaft Option (X/Y/Z), Units: mm					
	D	F	GA	KA	GB	KB	D	F	GA	KA	GB	KB
34	0.50 ⁰ _{-0.0005}	0.1250 ⁰ _{-0.001}	0.555 ⁰ _{-0.004}	1.0	0.473 ⁰ _{-0.004}	1.0	14 ⁰ _{-0.013}	5 ⁰ _{-0.03}	16.0 ⁰ _{-0.1}	45	13 ⁰ _{-0.1}	45
42	0.75 ⁰ _{-0.0005}	0.1875 ⁰ _{-0.0012}	0.830 ⁰ _{-0.004}	1.5	0.709 ⁰ _{-0.004}	1.5	19 ⁰ _{-0.013}	6 ⁰ _{-0.030}	21.5 ⁰ _{-0.1}	45	18 ⁰ _{-0.10}	45

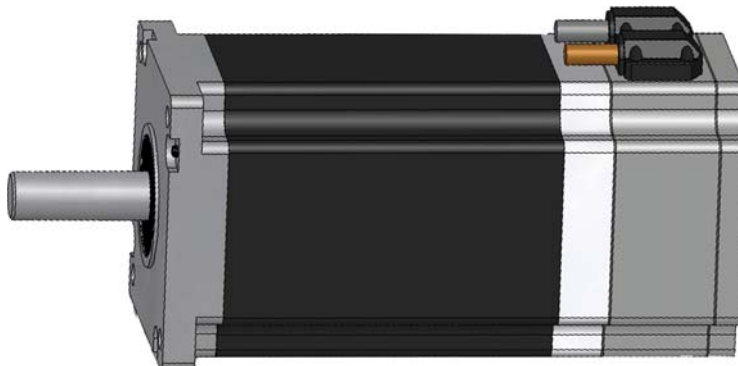

Mar, 20, 06

IG 34/42 with S Housing and HE Feedback

Power Cable Wire Code

Non Brake Power Wiring Diagram

Wire Code	Function
WIRE #1	PHASE U
WIRE #2	PHASE V
WIRE #3	PHASE W
GRN/YEL	Ground
Shield	Shield

SAB CC600CYT, 4 Pins, AWG16/20 (depending on current), 600V, 105C, UL, CE, CSA

Hiperface Encoder

Hiperface Encoder Data SRS 50, SRM 50

Parameter	Values
# of sine/cosine periods per revolution	1,024
Code type for the absolute value	Binary
Total number of steps (single SRS)	32,768
Output frequency for sine/cosine signals	0 .. 200 kHz
Operating speed (SKS)	12,000 min ⁻¹
Working temperature range	+ 5 ... + 115°C
Operating voltage range	7 ... 12 v
Recommended supply voltage	8 v
Max. operating current, no load	80 mA
Interface signals	
Process data channel=SIN, REFSIN, COS, REFCOS	Analogue, differential
Parameter channel = RS 485	Digital

Hiperface Encoder Cable

Wire Code	Function
BRN/BLK	REFSIN
BLK/BRN	REFCOS
BLU/BLK	DATA+
BLK/BLU	DATA-
ORN/BLK	+SIN
BLK/ORN	+COS
WHT/BLK	+7~12VDC
BLK/WHT	GND
RED/WHT	Thermistor 1
WHT/RED	Thermistor 2
Shield	Shield

Mar, 20, 06